











NRxTMH

NRXTMH21 : DINING HEIGHT

NOROCK are celebrating the geographic origins of their self-stabilising table base, the unique West Australian coastline, with **NRxTMH**, a limited-release collaboration with award-winning designers Tom Mark Henry. The **NRxTMH** table base uses NOROCK's patented next-generation mechanical self-stabilising technology with a design inspired by the undulating formations, organic textures and timeless colour palette of this isolated coast.

-  Powder-coated steel with a zinc phosphate layer for added corrosion resistance.
 -  715mm / 28.1" dining height, excluding table top
 -  530mm / 21" base diameter
 -  160mm / 6.2" column width
 -  fixed top plate
 -  17.8kg / 39.2lbs gross
 -  14.9kg / 32.8lbs net
 -  600 x 600 x 190mm - 23.6 x 23.6 x 7.4" x Box 1
 -  no-rock.com/product/NRxTMH
- Max recommended table top size:
-  800mm / 32"
 -  914mm / 36"

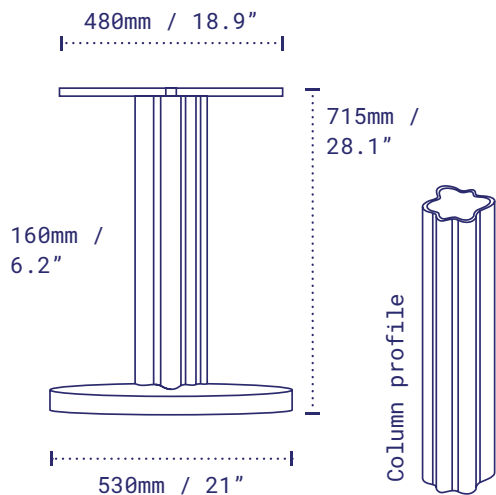

MADE TO ORDER IN THE FOLLOWING COLOURS:









-  **JARRAH BROWN**
Code: NRXTMH21JH
-  **LEEUWIN BLUE**
Code: NRXTMH21LW
-  **PEPPERMINT GREEN**
Code: NRXTMH21PM
-  **PINDAN RED**
Code: NRXTMH21PD



NRxTMH

NRXTMH21°C : COUNTER HEIGHT

NOROCK are celebrating the geographic origins of their self-stabilising table base, the unique West Australian coastline, with *NRxTMH*, a limited-release collaboration with award-winning designers Tom Mark Henry. The *NRxTMH* table base uses NOROCK's patented next-generation mechanical self-stabilising technology with a design inspired by the undulating formations, organic textures and timeless colour palette of this isolated coast.

-  Powder-coated steel with a zinc phosphate layer for added corrosion resistance.
-  915mm / 36" counter height, excluding table top
-  530mm / 21" base diameter
-  160mm / 6.2" column
-  fixed top plate
-  16.6kg / 36.6lbs gross
-  15.7kg / 34.6lbs net
-  550 x 550 x 70mm - 21.6 x 21.6 x 2.7" x Box 1
135 x 155 x 900mm - 5.3 x 6.1 x 35.4" x Box 2
-  no-rock.com/product/NRxTMH

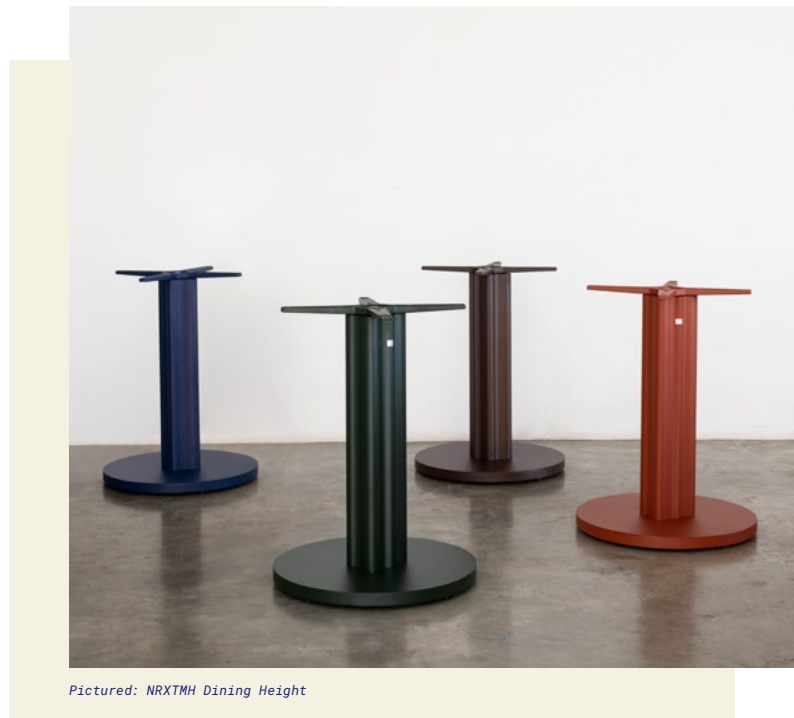
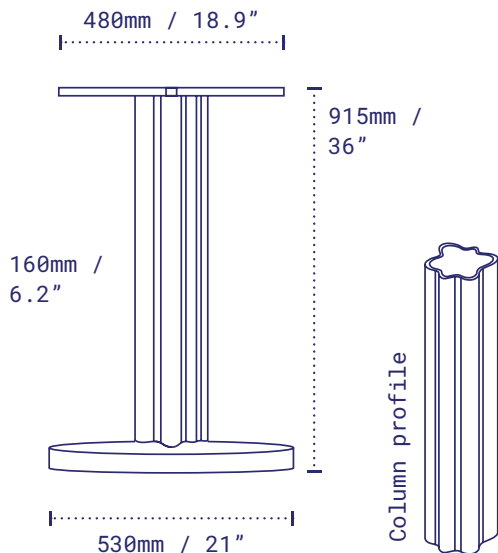









MADE TO ORDER IN THE FOLLOWING COLOURS:

-  **JARRAH BROWN**
Code: NRXTMH21JHC
-  **LEEUWIN BLUE**
Code: NRXTMH21LWC
-  **PEPPERMINT TREE GREEN**
Code: NRXTMH21PMC
-  **PINDAN RED**
Code: NRXTMH21PDC

NRxTMH

NRXTMH21*B : BAR HEIGHT



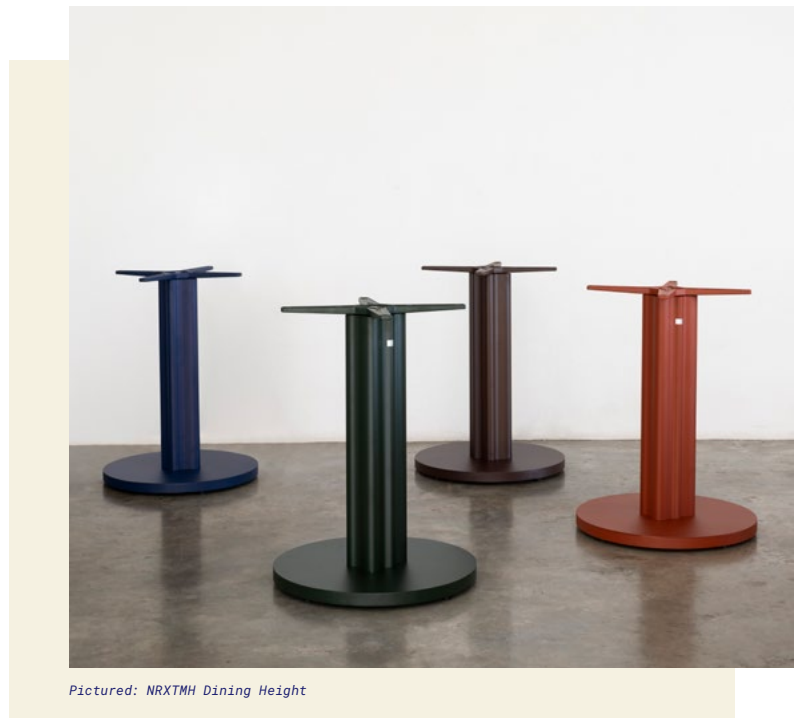
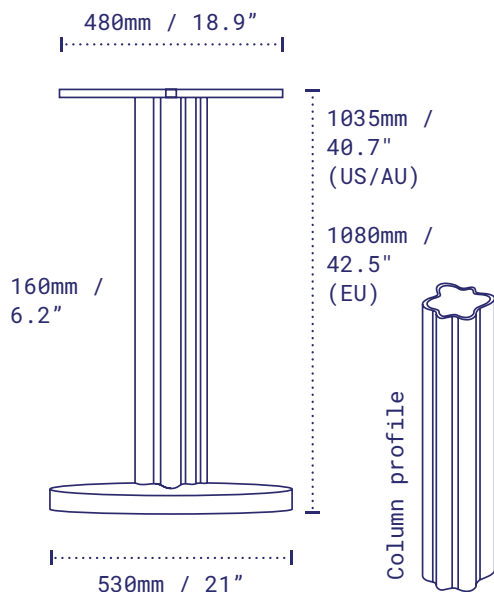

NOROCK are celebrating the geographic origins of their self-stabilising table base, the unique West Australian coastline, with *NRxTMH*, a limited-release collaboration with award-winning designers Tom Mark Henry. The *NRxTMH* table base uses NOROCK's patented next-generation mechanical self-stabilising technology with a design inspired by the undulating formations, organic textures and timeless colour palette of this isolated coast.

-  Powder-coated steel with a zinc phosphate layer for added corrosion resistance.
-  1035mm / 40.7" bar height, excluding table top
-  530mm / 21" base diameter
-  160mm / 6.2" column
-  fixed top plate
-  17.5kg / 38.6lbs gross
-  16.5kg / 36.4lbs net
-  550 x 550 x 70mm - 21.6 x 21.6 x 2.7" x Box 1
135 x 155 x 1055mm - 5.3 x 6.1 x 41.5" x Box 2
-  no-rock.com/product/NRxTMH

Max recommended table top size:
 609mm / 24" 762mm / 30"



MADE TO ORDER IN THE FOLLOWING COLOURS:

- | | | | |
|--|--|---|--|
|  | JARRAH BROWN
Code: NRXTMH21JHB |  | LEEUWIN BLUE
Code: NRXTMH21LWB |
|  | PEPPERMINT GREEN
Code: NRXTMH21PMB |  | PINDAN RED
Code: NRXTMH21PDB |

