

SLST17[CC*] : DINING HEIGHT

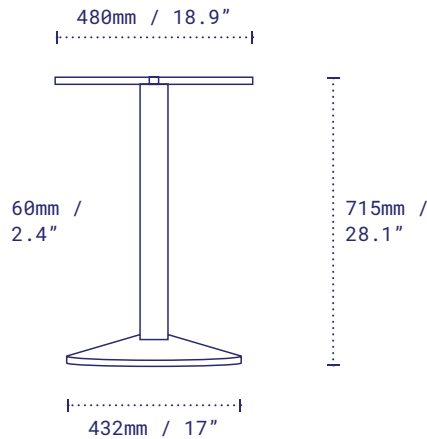

Sol is your go-to for maximising space. Our neat cone-shaped disc base allows for our self-stabilising technology to sit under the column, like our x-bases, and then run seamlessly flush to the ground at the feet.

Pictured: Sol 17 Dining Height, Sandstone Black.

DETAILS

Material	Steel – Zinc Phosphate Disc and Column, Alodine Top Plate
Next-Level Protection	Available on Request
Height excl. table top	715mm / 28.1"
Base diameter	432mm / 17"
Column width	60mm - 2.4"
Top plate	Fixed
Net weight	9.1kg / 20.1lbs
Max recommended table top	<input type="radio"/> 762mm / 30" <input type="checkbox"/> 660mm / 26"
Resources	no-rock.com/product/sol

PACKAGING

Carton	530 x 640 x 100mm / 20.8 x 25.2 x 3.9" x Box 1
Gross weight	10.6kg / 23.4lbs

STANDARD COLOUR RANGE

Sandstone Black
Code: SLST17BK

NON-STANDARD COLOUR RANGE

Antique Bronze
Code: SLST17AB

Ash Grey
Code: SLST17AG

Jarrah Brown
Code: SLST17JH

Leeuwin Blue
Code: SLST17LW

Metallic Silver
Code: SLST17SI

Peppermint Green
Code: SLST17PM

Pindan Red
Code: SLST17PD

Rust
Code: SLST17RU

White
Code: SLST17WH

SPECIAL COLOUR RANGE

Brass
Code: SLST17BR



SLST17[CC*]C : COUNTER HEIGHT

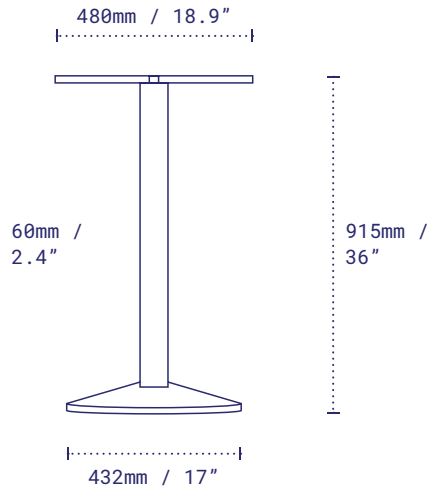

Sol is your go-to for maximising space. Our neat cone-shaped disc base allows for our self-stabilising technology to sit under the column, like our x-bases, and then run seamlessly flush to the ground at the feet.

Pictured: Sol 17 Dining Height, Sandstone Black.

DETAILS

Material	Steel – Zinc Phosphate Disc and Column, Alodine Top Plate
Next-Level Protection	Available on Request
Height excl. table top	915mm / 36" Counter
Base diameter	432mm / 17"
Column width	60mm - 2.4"
Top plate	Fixed
Net weight	9.6kg / 21.3lbs
Resources	no-rock.com/product/sol

PACKAGING

Carton	450 x 450 x 90mm / 17.7 x 17.7 x 3.5" x Box 1 70 x 70 x 870mm / 2.7 x 2.7 x 34.3" x Box 2
Gross weight	10.6kg / 23.4lbs

STANDARD COLOUR RANGE

Sandstone Black
Code: SLST17BKC

NON-STANDARD COLOUR RANGE

Antique Bronze
Code: SLST17ABC

Ash Grey
Code: SLST17AGC

Jarrah Brown
Code: SLST17JHC

Leeuwin Blue
Code: SLST17LWC

Metallic Silver
Code: SLST17SIC

Peppermint Green
Code: SLST17PMC

Pindan Red
Code: SLST17PDC

Rust
Code: SLST17RUC

White
Code: SLST17WHC

SPECIAL COLOUR RANGE

Brass
Code: SLST17BRC



SLST17[CC*]B : BAR HEIGHT

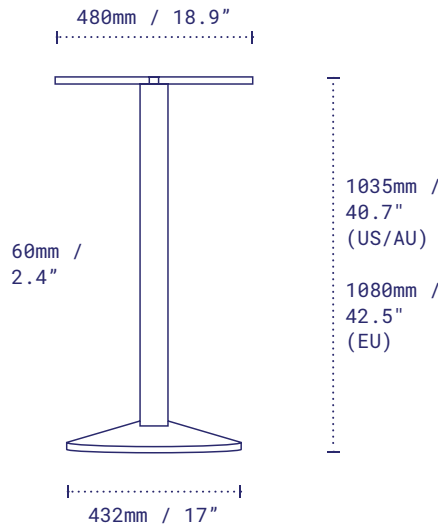

Sol is your go-to for maximising space. Our neat cone-shaped disc base allows for our self-stabilising technology to sit under the column, like our x-bases, and then run seamlessly flush to the ground at the feet.

Pictured: Sol 17 Dining Height, Sandstone Black.

DETAILS

Material	Steel – Zinc Phosphate Disc and Column, Alodine Top Plate
Next-Level Protection	Available on Request
Height excl. table top	1035mm / 40.7" Bar 1080mm / 42.5" Bar (EU only)
Base diameter	432mm / 17"
Column width	60mm - 2.4"
Top plate	Fixed
Net weight	9.9kg / 21.8lbs
Max recommended table top	<input type="radio"/> 558mm / 22" <input type="checkbox"/> 508mm / 20"
Resources	no-rock.com/product/sol

PACKAGING

Carton	450 x 450 x 90mm / 17.7 x 17.7 x 3.5" x Box 1 70 x 70 x 1035mm / 2.7 x 2.7 x 40.7" x Box 2
Gross weight	11kg / 24.2lbs

STANDARD COLOUR RANGE

Sandstone Black
Code: SLST17BKB

NON-STANDARD COLOUR RANGE

Antique Bronze
Code: SLST17ABB

Ash Grey
Code: SLST17AGB

Jarrah Brown
Code: SLST17JHB

Leeuwin Blue
Code: SLST17LWB

Metallic Silver
Code: SLST17SIB

Peppermint Green
Code: SLST17PMB

Pindan Red
Code: SLST17PDB

Rust
Code: SLST17RUB

White
Code: SLST17WHB

SPECIAL COLOUR RANGE

Brass
Code: SLST17BRB

